



Product Features

- Multichip Hybrid Module
- GaAs p-HEMT & E-pHEMT chip on board
- No matching circuit needed
- High IP3 & Low Noise
- Single Supply Voltage (+5V)
- Surface Mount Hybrid Type
- Tape & Reel Packaging
- Small Size, High Heatsink
- Alumina Substrate
- Pb Free / RoHS Standard

Applications

- 2G & 3G Repeater
- Base Station
- PCS, CDMA, W-CDMA
- GSM, DCS, UMTS
- WiMAX, Wibro, WLAN
- RF Sub-Systems

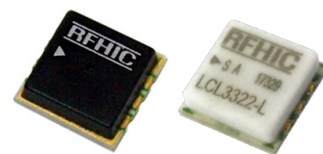

Package Type : CP-16B

CP-16BL2(Option)

Description

RFHIC's LOW Noise Amplifier series are all hybrid LNA type products which includes all matching for the convenience of customers. LCL series are focused on higher OIP3 while maintaining low noise. The structure of the device is built with GaAs p-HEMT die attached on a ceramic thick film substrate. The device is still smaller than the area one would use for the application notes all together. Depending on the part number, one can use this in different frequency applications. All LNA hybrids are possible to have custom frequency & spec without any additional NRE cost involved. All RFHIC products are RoHS compliant.

Electrical Specifications

PARAMETER	UNIT	MIN	TYP	MAX	Remark
Frequency Range	MHz	2700	-	3800	-
Small Signal Gain (S ₂₁)	dB	-	21	-	@ 3250MHz
Gain Flatness	dB	-	±1.0	-	-
Input Return Loss (S ₁₁)	dB	-	-13	-	-
Output Return Loss (S ₂₂)	dB	-	-14	-	-
1dB Compression Point (P _{1dB})	dBm	-	27	-	-
Output 3 rd Order Intercept Point (OIP3) (TYP.)	dBm	-	39	-	-
Noise Figure (TYP.)	dB	-	1.4	1.7 1.5*	Max 2.2 @85°C
DC Supply Current (V _{dc} =+5V)	mA	190	220	250	-

Test Condition

- ① Supply voltage = +5V, 50ohm System, Ta = 25 °C
- ② OIP3 is measured with two tones, at an output power of +15dBm/tone separated by 1MHz.

* NF Sorting (Max : 1.5dB) : Marking "S"(Page 4)

Absolute Maximum Ratings

PARAMETER	UNIT	RATING	REMARK
Device Voltage	V	6.5	-
RF Input Power	dBm	+15	CW
Junction Temperature	°C	180	-
Operating Temperature	°C	-40 ~ 85	-
Storage Temperature	°C	-50 ~ 125	-

Note

Operation of this device in excess of any one of these parameters may cause permanent damage.

Functional Diagram

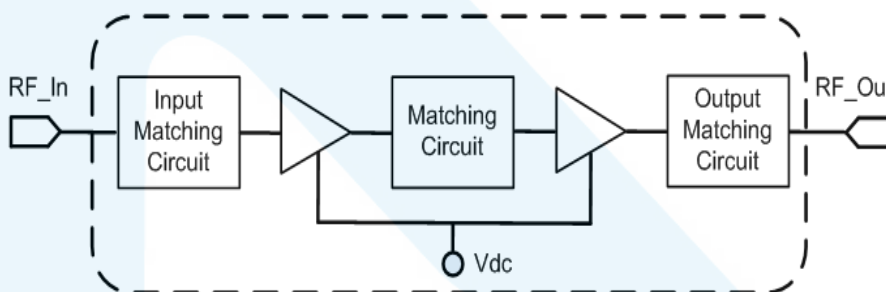

Application Circuit

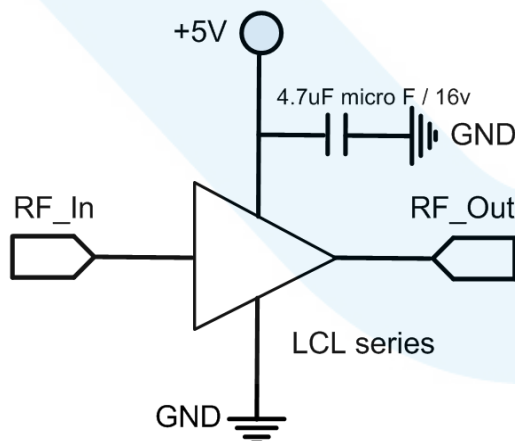

ESD Protection

Gallium Arsenide Integrated Circuits are sensitive to electrostatic discharge (ESD) and can be damaged by static electricity. Proper ESD control techniques should be used when handling these devices. Some of the precautions recommended are;

- Person at a workbench should be earthed via a wrist strap and a resistor.
- All mains-powered equipment should be connected to the mains via an earth-leakage switch.
- Equipment cases should be grounded.
- Relative humidity should be maintained between 40% and 50%.
- An ionizer is recommended.
- Keep static materials, such as plastic envelopes and plastic trays etc. away from the workbench.

Package Dimensions

(LCL3322-L, Type: CP-16B)

* Unit: mm[inch] | Tolerance $\pm 0.15[.006]$

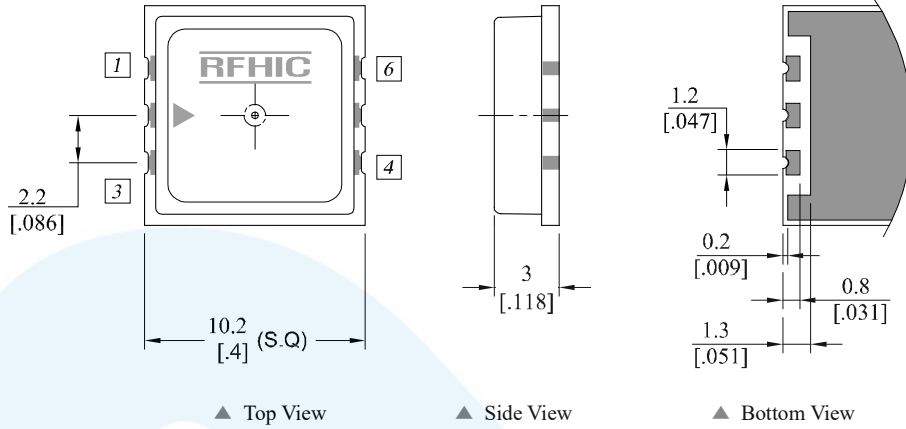

(LCL3322-L(SA), Type: CP-16BL2)

* Unit: mm[inch] | Tolerance $\pm 0.15[.006]$

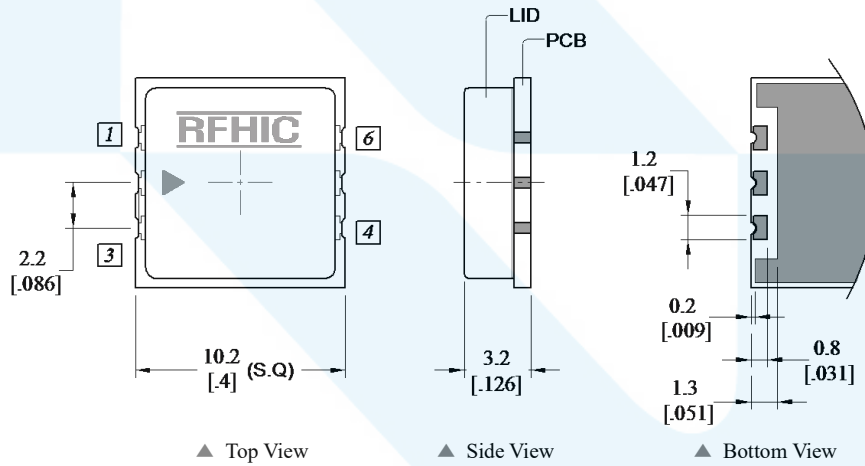

Pin Description			
Pin No	Function	Pin No	Function
1	GND	4	Vcc
2	Input	5	GND
3	GND	6	Output

Recommended Pattern

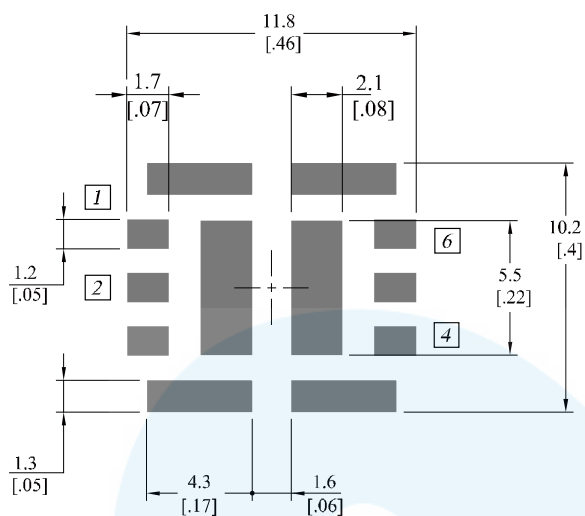

Recommended Mounting Configuration

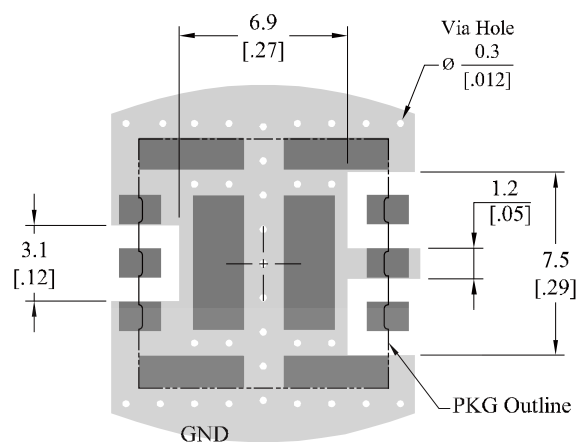

*** Mounting Configuration Notes**

1. Ground / thermal via holes are critical for the proper performance of this device.
2. Add as much copper as possible to inner and outer layers near the part to ensure optimal thermal performance.
3. Mounting screws can be added near the part to fasten the board to a heatsink. Ensure that the ground / thermal via hole region contacts the heatsink.
4. Do not put solder mask on the backside of the PCB in the region where the board contacts the heatsink.
5. RF trace width depends upon the PCB material and construction.
6. Use 1 oz. Copper minimum.

Marking Information

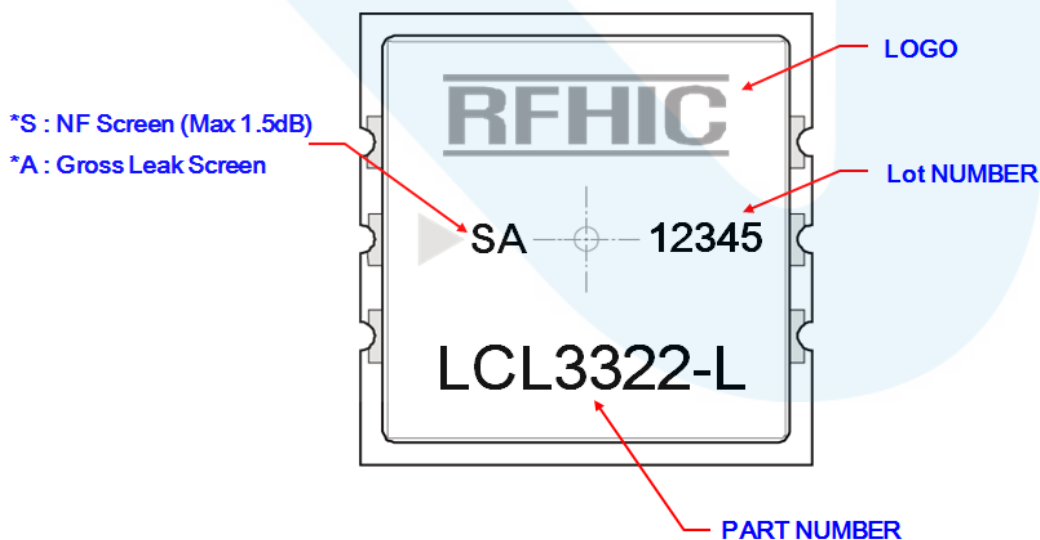

Mechanical Specifications

PARAMETER	UNIT	TYP	REMARK
Mass	g	0.45 0.7(SA)	-
Dimension	mm	10.2 x 10.2 x 3.2	-

Revision History

Part Number	Release Date	Version	Modification	Data Sheet Status
LCL3322-L	2024.02.21	1.3	Added Maximum Junction Temperature & Optional : LCL3322-L(SA) Information	-
LCL3322-L	2021.04.15	1.2	Added Maximum Input Power Level	-
LCL3322-L	2012.10.19	1.1	New datasheet format	-
LCL3322-L	2011.2.08	1.0	Initial Release	-



Certification

This product is manufactured by a company that is certified for the AS9100D quality management system.

RFHIC Corporation reserves the right to make changes to any products herein or to discontinue any product at any time without notice. While product specifications have been thoroughly examined for reliability, RFHIC Corporation strongly recommends buyers to verify that the information they are using is accurate before ordering. RFHIC Corporation does not assume any liability for the suitability of its products for any particular purpose, and disclaims any and all liability, including without limitation consequential or incidental damages. RFHIC products are not intended for use in life support equipment or application where malfunction of the product can be expected to result in personal injury or death. Buyer uses or sells such products for any such unintended or unauthorized application, buyer shall indemnify, protect, and hold RFHIC Corporation and its directors, officers, stockholders, employees, representatives and distributors harmless against any and all claims arising out of such unauthorized use. All sales inquiries and support should be directed to the local authorized geographic distributor for RFHIC Corporation. For customers in the US, please contact the US sales team through our website at <https://rfhic.com/rfhic-us/>. For all other inquiries, please contact our international sales team through our website portal at <https://rfhic.com/contact/>